

## First Flight

*continued from page 1*

uMonitor, Navaid wingleveler, ADC screen oil filter; used Bob Nuckolls' schematics for wiring, B&C automotive fuse blocks and busses, temper foam seat cushions; left off bottom winglets, ran polypropylene tubes down the keel to run the brake lines in (for easy replacement); made the nose access door bigger; installed the lighter bellville washers and nyloc nut for the shimmy damper; and did the internal rudder belhorns. I used Dupont Basecoat/Clearcoat paint - very easy to use. Performance 3 blade 65x75. Engine is an IO360 C1C6 out of an Arrow. CHT's run about 180 C and fairly even after a little adjustment with the inlet baffle ramps. Oil temps run 100 to 105 C, only got to 112 C in a quick climb to 12,000 (redline is 118 C).

As far as do's and don'ts - the hardest part was working from the sketchy instructions in the old manual; and it's still going to be hard with the new manual - it's organized better, but still needs improvement to make the instructions clearer. The building process went fairly well, only a glitch now and then because I was so close behind the prototype building. I would not use the fuel caps provided with the kit - cannot get them to seal properly even with adjustment and lubrication. I'm thinking about ripping them out and putting in the newer ones. I wouldn't use the throttle and mixture cables from the factory, I'd get some with a vernier adjustment. I didn't use phillips head screws for cowl, rudder hinge, etc. Instead I used hex head SS socket (available from McMaster Carr). I had to weld some 1/4" bar stock onto the door handles because the originals are too flimsy when the weather stripping is uncompressed (people will see what I mean).

My longest flight so far was a trip from Oshkosh to Winterhaven, Florida. Everything ran well, no real complaints except for fuel leaking out of the fuel caps. I would really recommend the Navaid wingleveler and the Strikefinder for long cross country trips - they both work great.

*John Vukos*



*John and Gail Vukos, proudly pose before their beautiful new Velocity RG Elite*



*John is all smiles just moments after engine shut down from his first flight*



*John's impressive panel includes a Strikefinder, RMI, and auto pilot*

## Let's be constructive when we complain!

I have been sensing a bit of friction between a few builders and the factory of late about things like the manuals or the tapes. If this does not apply to you, I apologize for preaching to the choir!

Prior to addressing the manuals, we must all realize that we each have a vested interest in seeing Velocity Inc. staying successful and profitable. Remember what happened to the value of the Long EZ when Rutan filed for bankruptcy protection due to the threat of a law suit? A strong Velocity Inc. run by the Swings means we continue to get strong builder support, new advances, and a continued market for our unfinished kits or flying Velocities, should we decide to sell. Therefore, as a builder, we each have a unique partnership with the Swings to make things right!

As a builder, I want a perfect manual. But in the real world, there is no perfect manual. So what action should I take when I find a mistake, or a section that needs clarification, or perhaps an improved drawing? Do I:

A) Call the factory to complain and make destructive comments about the manual? or  
B) Call the factory, point out a problem I found, and make a constructive suggestion as to how I think it can be fixed.

Obviously, (I hope), option B will get the best results and keep us all friends. Those very few builders that chose option A end up putting the Swings on the defensive and make it very difficult for the rest of us when we call to suggest a change in the manual.

Jeff Baker is now the factory's key man in coordinating KPCs and improving the manual on an on-going basis. Each of us builders has a duty to get the manual as close to

*Continued on next page*

# INVOICE

**Time to Renew your subscription for the '97 Calendar Year! If your label reads "Paid thru Vol 8", then this is your last newsletter unless you renew. Please do it ASAP, but no later than 12/20/96. No other notice will be mailed!**

## Subscription Order Form

**Renewal**

**New Subscription**

*For renewals, please check your mailing label (last page of the newsletter) for accuracy.*

Name:

Mailing Address:

Home Phone #:

Work Phone #:

Fax #:

(If) e-mail address:

(If) Factory DMO #:

(If) Which Model Velocity:

(If) Registration #: N

(If) Velocity now flying?:

---

### 1997 Calendar Year Subscription (Volumes 9-12):

\$ 35.00 in US funds for addresses within the United States

\$ 43.00 in US funds for International addresses (extra \$8 covers air mail plus special handling)

### 1996 Back Issues (Volumes 5-8):

\$ 35.00 in US funds

### 1995 Back Issues (Volumes 1-4):

\$ 35.00 in US funds

Payment method (check one box):  **Check enclosed** (US Bank or International Money Order)

**Master Card**



**Visa**



Card # \_\_\_\_\_ Expiration Date \_\_\_\_\_

Print your name as it appears on your credit card: \_\_\_\_\_

Your Signature authorizing us to charge your credit card: \_\_\_\_\_

NOTE: Your credit card statement will show the charge in the name of Lavoie Graphics

**Mail** with your payment to:

Rick Lavoie, 26 Marshview Dr, St. Augustine FL 32084-5873

Or you can **Fax** to 904-461-3146 if paying by Master Card or Visa

All Planes. This hint was mentioned in an old newsletter but has been overlooked by many so we will repeat it. When microing the foam before glassing, let it sit for 1 hour or so before you glass over to allow the micro to begin to tack up a little. If you do this it will help in three ways. First, if you are glassing the wings it will help hold the bottom two layers of glass while you pull the squiggles out of the Uni. Secondly, when you start wetting out the cloth, the epoxy will not mix as much with the micro. Third, there is styrene in the epoxy which tends to melt the wing foam a little as it is curing. The partially cured micro acts as a barrier.

## Franklin Engine Project Update

The Franklin engine has been performing as we expected. With the fixed pitch prop we will need about a 2550 static RPM as a minimum to achieve proper take-off distance. This will result in the need to throttle back a little at altitude to keep the RPM from exceeding 2800 RPM. True airspeed has been about what we expected and has been averaging about 8 KTS more than a similar Lycoming. The engine has been running smooth at any RPM above 1200. Below this RPM expect the engine to run rough. A Velocity builder, Dave Lincoln, has been doing some ground testing with the Lycoming using the fuel injection system and a dual electronic ignition system from Electroair. By changing the timing (electronically) he has been able to achieve a smooth idle down to 750 RPM. If you elect to stay with one mag, it would be necessary to shut the mag off during idle and taxi. Manifold pressure brings the timing back to the required advance once above 1200 RPM. The fuel injection nozzles were moved to the bottom of the cylinders and with this set-up, static RPM is the same as with the carb. Dave is working with Air Flow Performance and Atlas Motors and you can check with Pat at Atlas if you need more information regarding this change. The fuel injection will add about \$1,000.00 to the price of the Franklin (compared to the car-

buretor version). You will also need to purchase a dual pack electric fuel pump set-up from Air Flow as no engine driven fuel pump is available to run the fuel injection system properly. This will also require some sort of back-up battery pack, with a diode to prevent discharge, for emergency fuel pump operation.

We have also been flying with the IVO pilot adjustable electric prop. Take-off and climb performance are spectacular. As expected, cruise is about 3 to 4 KTS slower than the fixed pitch prop but certainly good enough. The major problem is the ability of the small electric motor to bring the RPM down once at altitude. At 9000 feet density, the lowest I can get the RPM with full throttle (23" MP) is 2700. Fuel flow is about 10.5 GPH and speed works out to about 204 KTS true (234 MPH). Pulling the throttle back to 21 inches, fuel flow went down to 9.0 GPH (leaned to peak EGT), and the RPM settled on 2550. This will yield a true airspeed of about 187 KTS (215 MPH). In all the tests, I was carrying about 50 gallons of fuel, and flying solo.

Cylinder temperatures are running 360 degrees maximum on the hottest cylinder #1, and about 354 degrees on the coldest cylinder #4. Oil temp peaks at about 220 in the climb and then back down to about 210 in cruise.

Other than putting more hours on the IVO prop for confidence, there isn't much more for us to do. All the engine install package parts are in, or on order, and should be ready to ship by the time you read this. The install package is for the carb version only. Prices can be found in our latest option catalog, which was recently mailed to you.

## GENERAL NEWS

Some of you are still using the (561) 589-1860 phone number when trying to call us on the weekend. We will not answer this number on Saturday or Sunday if we were working because we went to the trouble of putting in an unlisted number just for you builders. It is (561) 589-0309. If you can't get through to us during

the normal work day on our regular number, try the unlisted one.

The area code for Sebastian has changed to 561. The old 407 will continue to work into next year, however, you can change now to the new one.

The girls here in the office told me that some of you have complained about us wanting to charge for the new construction tapes, even to the point of telling us we have no business charging anything for the cost of shipping to get these tapes to you. Those of you who are building a non-elite model do not NEED new tapes. They are a convenience to you but not absolutely necessary. To those who are building the Elite, we will give you the Elite portion at no charge. The wing construction is the same as what you have now except in much greater detail. Hearing that we should not charge for these tapes and should prepay the shipping charges has become an irritation to me. We have spent over \$12,000 to date just for the editing of these tapes. This doesn't include the hours and hours of time spent by Mark and Nancy in making them available for the editor, nor does it include the production cost.

Here is what we are going to do: If anyone wants all or part of the new tapes, they are yours for the reproduction cost. This will average \$5.00 per tape. I'm not sure how many total we will end up with, but probably around 12. Those of you who need the Elite tapes on the doors and keel installation, these will be sent to you at no charge. All you need to do is ask. Don't ask yet, however, because we don't have them ready.

We built our first Velocity back in the late 80's with NO tapes and a construction manual about 1/4 the size of the present one. Most kit aircraft, and no plans airplane that I'm aware of, have construction tapes. There are about 80 Velocities flying and many of these had no tapes or, at best, the old tapes. Ever wonder how this could be?

Give us some slack, guys, we're doing the best we can.

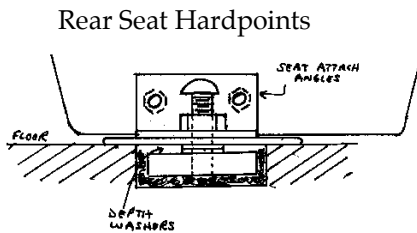

stir sticks hold the seat flush with the floor and the washers set the H/P down into the hole. Additional washers are used above the stir sticks to get the front seats level.

- Now simply set the entire seat or frame into the microglased holes as an assembled and aligned unit.
- After cure, finish and re-tap according to the instructions.

7. RG NOSE GEAR LOCK. Am I the only one that can't sleep worrying about nose gear collapsing? I found a solution that almost seems like it was designed in. About 6-3/4" above the nose gear pivot bolt is another bushing hole in the gear (I have no idea what it's for). Simply drill a hole all the way through the keel (start small and file for alignment) and run a 6" x 3/8" bolt through to lock it (the keel is even reinforced in this area). I also made some brass bushings for the holes. EZZZZZZ!

8. An earlier newsletter mentioned the need for a torque tube arm and

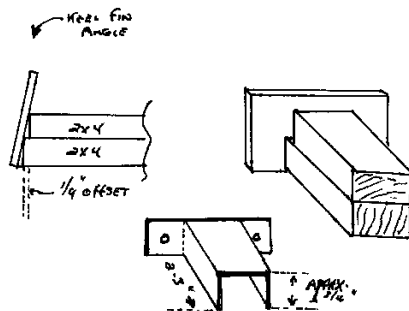

main gear CYLINDER ROD SHIELD to prevent them from touching. I built one using two short pieces of 2x4 with an angled top piece of wood to form a T. Duct tape the 2x4s together offsetting the ends about 1/4". Attaching the end cross piece to the uneven ends will form an angle that matches the floor to keel fin angle. Then duct the inside of the

# Views from the West



Open House Schedule: The photo is an example of our "hands



on" fiberglass lay-up class. We offer this topic on a repeat basis for open houses because it gives people the experience of doing a lay-up correctly and the confidence to undertake a Velocity project. Our "students" are always impressed with how easy the lay-up task actually is.

Our September Open House topic was to introduce the new West Coast demo, N94VA. Everyone got a chance to sit in it, although it wasn't ready for demo rides until October. Gotta fly off those 40 hours.

Remember, the monthly "Open House" at Velocity West is the first Saturday of each month, from 9AM to 3PM. The only month we see being cancelled in the near future is October, due to our expected attendance at the Golden West Fly-in at Tracy, California during that first weekend.

**VIDEO CONSTRUCTION TAPES:** The updated "Introduction" and "Wings, Winglets & Canard" construction tapes are now available

from our home office in Florida. We are in the process of editing the remainder of the tapes and as each phase of construction becomes edited we will be making them available. If you're a builder you are aware of how the process goes — as an example, you may only be able to construct a door to a certain point; you then have to put it aside, complete another part of the aircraft and then come back to the door. Our taping is exactly a reflection of that process — once the entire aircraft is finished we can start "sorting" the tapes! Our goal is to have the entire set available by the end of this year.

**SERVICE CENTER:** Our inventory of aircraft under construction in the shop is constantly changing; we have kits with builders here on a revolving "short term" basis. Give us a call if you're in need of some assistance with finishing a particular part of your project or if you would like some extra help with the initial/start-up part of your project.

Our program requires the builder to be "on-site, with the staff at Velocity West providing assistance and guidance, in a work intensive environment. We expect you to get a lot done in a very short period of time!!

Well, that's all for now. I think I hear Mark calling for a videocam operator person (new generic term for cameraman)!

*Nancy Machado*

end piece forming a nice radius and do a 4 BID lay-up over it all. The T end forms flanges to attach to the keel fin. The final piece should be 2"-3" long with about 1-3/4" sides. Cut and file the sides to adjust the height to be midway between the arm and cylinder rod washer. To attach, drill holes in the fin 3/4" in from the keel and 3/4" up from the floor.

'Nuf for now.

P.S. My local Western Auto Store has a free tool loan program (tube benders, etc.) and even loaned me a dummy floor model battery while building the tray. Check them out....



only know Bob paid the ultimate price. Bob will be missed by me and his many friends.

In another accident, the Velocity pilot was flying low over unfamiliar territory when a banging sound in the engine compartment was thought to be the beginning of an engine failure. Rather than risk flying any further, this pilot elected to get the plane on the ground ASAP. The landing was in a soft cotton field, however, in this case, soft ain't good. The nose dug in and the plane flipped over on its back trapping the pilot inside. His son was small enough to slip through the partially open door and get help to get the pilot and another passenger out of the airplane with no injury to anyone. The banging noise was found to be an exhaust pipe that had broken off and was flying around in the engine compartment. Although he might have been able to get to an airport successfully, his decision to get the airplane on the ground NOW was the right one. He has already started re-building his Velocity.

Another pilot, still in the restriction phase of his flight time, had a cylinder fail with only about 35 hours since overhaul. He made a successful landing on a small road with no damage to the airplane. No word yet on what caused the cylinder to fail.

We also received another report of an exhaust breaking off aft of the #2 cylinder. The broken part went through the cowl opening and took a chunk out of his three bladed prop. The airplane proceeded to the destination airport without further incident. The prop can be repaired. In this case and the one above, it might have been possible to detect the broken exhaust before flight by tapping the pipe with a coin. A cracked exhaust will have a very distinct sound when compared to one that isn't cracked.

That's it for this issue. Let's hope I'll not have to do this again next issue.

## First Flights

In the last newsletter I proposed the question as to our test flying your

airplane for the first time. The response was, more or less, split on this issue. Some of you gave me excellent reasons why we should provide this service, others suggested strongly that our value to the future success of Velocity would be placed in jeopardy should anything happen during one of these first flights. Certainly, our experience in knowing the airplane as we do could provide valuable information to the builder during this first flight. On the other hand, it is rare that everything can be accomplished during this first flight. More often than not, high cylinder temperatures on one cylinder, high oil temperature, sloppy or stiff controls, and a variety of other things could result in the need for more flight testing. These are things that require time to fix and my time (and Scotts) would not allow a two or three day wait for these things to be sorted out.

I had many suggestions that Scott or myself provide a thorough Factory preflight inspection and a taxi test and then let the owner/builder do the actual first flight. This make a lot of sense but probably doesn't go far enough for the cost involved.

Many suggested that as part of the first flight would be a check-out for the pilot. Legally, this is not possible. The rules provide that essential crew only be used for the time necessary for the restriction fly-off. Essential crew for a Velocity does not include a co-pilot.

What, then, can we do? The answer may come from one of our professional builder/professional pilot individuals who called me and said he would be willing to do the inspection/first flight of a Velocity. He is presently flying the Velocity he built, and is checking out the owner as you read this letter. He would require that the FAA inspection be complete, engine run to full power with a minimum of 2400 RPM static, high speed taxi tests be completed (no lift off) and any problems associated with these tests be addressed and fixed. The price for his services would be agreed upon prior to his arrival and any work performed by

him to fix a problem could result in additional costs. If interested, call: Roger Messenger, Messenger Air Ltd., Rt. 3 Box 63, Sigourney, IA 52591, Phone 515-472-5521

## Lycoming Mandatory Service Bulletin

Lycoming has issued a service bulletin on the engine driven fuel pumps used on the injected engines. The identification code is stamped on the flange of the pump and those affected are #154739506, 154739507, and 154739510. If you have one of these pumps installed on your engine, you will need to get a copy of the service bulletin #525, and inspect the pump per the bulletin. (I have a copy if you need one). Failure of the pump causes total fuel flow blockage and the electric pump will not solve the problem. This is not good. Compliance is listed as, "before further flight."

## Deep Stall

Under certain conditions, a deep stall is possible. An aft CG, with an attempt by the pilot to stall the aircraft, could cause a deep stall. This is a condition where the airspeed will go to "0" as the airplane descends in a "flat", wings level, attitude.

An airplane within the aft CG limit could also be "deep stalled" if a hammerhead type maneuver was attempted. This would be a pilot induced pull-up to a vertical line until airspeed drops to "0". The resulting fall would likely be a "deep stall".

If intentionally or unintentionally in a deep stall, the following should be accomplished post haste:

1. Extend the landing gear (if an RG)
2. Apply full power
3. Apply full nose down stick pressure
4. Hold nose down until airplane "flies out" of the deep stall

Using this procedure, the Velocity factory test aircraft N81VA was successfully flown out of the deep stall with a 1200 feet altitude loss and a 12 second time lapse.

signal, but power reflections can damage your transmitter. All this to save \$45? Maybe someone will explain it to me.

••••••••

*From Rick Lavoie, St. Augustine FL*  
**Fuel caps & sight gauges and nose gear guides**

The photo below shows the lock-



ing fuel caps I recently installed in the upper strakes. I purchased them from Velocity for \$95 each. They are of very high quality and will not leak. This is a brand new option that the Swings are offering. They also sell a less expensive one for \$42 that has no lock. If you have yet to install your strakes, I recommend that all of you use this new fuel cap. This will give you a nice seal, and combined with Scott's new venting system, will give you even fuel flow from both tanks.

Instead of the tube sight gauge that comes with the kit, I purchased an enclosed sight gauge used in



many "Rutan" type EZ's from Vance Atkinson for \$40. They look beautiful and are built for both av and auto fuel. But, since it was manufactured to fit EZs, it will not show the top 5 gallons of fuel. If you get one, be sure to follow Vance's instructions to the letter and mount it as low as possible. Also, you must remove the

foam in a large enough area where the top and bottom fuel holes are located. If you failed to do this, fuel would get into your foam on that fuel bulkhead and eventually find a way to your cockpit cabin area. I filled this area with very wet micro glass and covered with 2 layers of fine BID both sides for a glass to glass bond. Once cured, I made an upholstery trim piece, so that the only thing that will show will be the gauge itself. To make this trim piece, I used the same technique (explained to me by Duane) that I used to make the trim pieces for my windows. By the way, if you don't know what I'm talking about, be sure you make upholstery trim pieces for around your windows before you glass your top half fuselage together! You need to turn your top half upside down to do this. To make any upholstery trim piece, you need to duct tape the section you are making the trim piece for, then mark an outline with a permanent black marker right on the duct tape. You are making a mold right on the part and the duct tape allows you to release your trim piece from that part. Pre wet your tape, then lay strips of BID within the black marks you made, and peel ply. Let cure, sand your edges smooth, check your fit and you now have an upholstery trim piece that is a perfect fit (see photo). Oh by the way, do not



use any upholstery screws on your bulkheads that have fuel on the other side. Seems obvious, but you never know.

Back to the fuel sight gauges. To buy a set, send \$40 to Vance Atkinson, 3604 Willomet Ct., Bedford TX 76021

The last photo shows a guide for my nose gear. Without this guide, it is possible that the nose tire may



shift enough so that when I want to land, my nose gear may not come down. Not a pretty thought! I already landed once with my nose gear up in my Long EZ! Once is enough for me. Although there are no incidents of this type reported to the factory, I decided to play it safe and install the guides. With the G's I will be pulling flying aerobatics, it seemed the safe thing to do. I had seen this done a number of ways by other builders, but really liked the way Dave Black installed his. He simply made a bulkhead that gives the gear no choice but to go down.

Remember when you glassed (or will someday get to it) sheets of foam on both sides for your fuel bulkheads and baffles? Well I had some of that material left over and used it for this purpose. I first made cardboard templates for the four pieces needed (2 pieces on each side). I then used 4 minute epoxy to hold them in place. I hollowed out foam about 1/2" on the tops and sides, filled with micro glass (or flocked cotton "flox"), finger radius all corners with micro glass, then applied 2 BID tapes to glass in place. They are rock solid and my tire has no choice but to come down, no matter how many G's I pull! Hugh Hyde called me the other day and suggested that the nose gear guide be published in the newsletter. By coincidence, I had just finished glassing mine (thanks to my recent trip to Dave Black's shop).

A few other random thoughts to share with some of our newer builders. The concentric torque tube for the elevators is a must have option. I love mine. Having owned a Long EZ, I am thankful to Scott for inventing this little marvel. It means no more cold feet! Go through the Velocity Option Catalog. You will

## Short Circuit

*Continued from page 7*

remember having their airframes degaussed (de-magnetized) because of the tubes coming down from the roof to the center of the windshield. Remove any questionable items one at a time. If no change is noticed, reinstall it.

If you do not find anything of steel that is effecting the compass, start removing pieces of electronic or electrical equipment. Some high tech digital radios use magnetic impulse coupling to select radio frequencies, adjust OBS settings on Navigation indicators, etc. Some automotive type indicators with pointers use relatively large magnets to move the needles. Once you have found the culprit, replace it or relocate it. Then go back to the top of the second paragraph.

Believe it or not, you are allowed up to 10 degrees in error, provided the compass correction card indicates the erred reading for the true magnetic heading you wish to fly! Obviously, the more accurate the reading on the compass, the less cockpit confusion there is to overcome.

### How to Safety Wire

Those of us that have trained and/or have been educated in the field of aviation construction and maintenance take for granted a good many things that seem so basic and simple, that we forget a simple fact. Most builders of experimental aircraft have their talents and expertise in areas other than aircraft construction and maintenance, and the lack of basic techniques used in construction and maintenance needed in aviation. It is the goal of this feature to discuss the procedures and objectives of many of these 'simple things' that most builders have never done.

This particular article has been inspired by the recent inspection of a 'safety wire' job done on a prop by one such builder.

The objective of safety wiring something is simple...prevent the bolt (or bolts) from loosening and



backing out. The proper technique used to accomplish this is not so simple. It is not difficult though, either. For this discussion, refer to drawing above. (Those of you who know about drafting and drawing will quickly realize that I don't!)

Again the objective is simple, prevent the bolt(s) from loosening, or turning counter clockwise. To properly safety wire these two bolts you need to do the following: Cut a sufficient length of safety wire that will allow at least 1 1/2" of wire on the final twist. Now insert the wire in the top bolt head and bring the end coming out of the 8 o'clock position OVER THE TOP of the bolt (clockwise rotation) and BEHIND the end coming out of the 2 o'clock position. Hold the two wires together, and by making a backward "S" between the two bolts, determine the length needed to reach the 10 o'clock position of the bottom bolt. Now twist these two wires in a clockwise rotation so that there is a dual, intertwined, spiral staircase effect (double helix). Do not wrap one wire around the other like an outside staircase on a lighthouse. The end coming out of the 8 o'clock position needs to be behind the 2 o'clock position to help insure that it does not 'slip' over the bolt head. The short distance of wire that we are talking about is effectively the "pull wire", keeping the top bolt from loosening.

The twists of the safety wire should end right at the 10 o'clock position of the lower bolt when pulled snugly from the top bolt. The

wire that should be inserted into the hole is the one that comes closest to comfortably "rolling" into the hole. The other end will automatically fall behind the wire going through the bolt safety hole and it should continue around, in a counter clockwise manner, behind the wire exiting the 4 o'clock position. Tightly pull the wire that wraps around the bolt head and twist it snugly at the base of the wire exiting the 4 o'clock position in a clockwise rotation. (Remember, behind the wire exiting the hole and twist it in a double helix!) Twist these two wires approximately 1 1/2". Now cut the twist 1 inch from the bolt head and double the twisted wire back so the end just touches the bolt.

If any safety wiring job has been done properly, you should be able to observe the following;

- 1) If one bolt tries to loosen, it will try to tighten the other bolt.
- 2) No wire, except the last 1", has a single point bend greater than 90 degrees.
- 3) The wire that 'wraps' the bolt head will not pull over the side of the bolt head, allowing it to be on top of the bolt head.
- 4) There is moderate tension on the twisted wire between the two bolt heads. Any movement of either bolt should result in movement of the other bolt.
- 5) No wire should protrude higher than the head of the bolt.
- 6) A full or partial backward "S" should be visualized with the wires wrapped around the bolt heads forming the 'hooks' of the backward "S".

A rule of thumb for the diameter of the safety wire needed, it should be at least 1/3 the diameter of the hole it is going into.

As it is with everything, to safety wire properly takes some practice. Seldom does anything such as this come naturally. It is not difficult to do correctly though if you know what you are trying to accomplish.

Safe and Speedy Construction!

speeds. The Velocity's third unique feature is its roll stability caused by the vertical positioning of the winglets. Wing tip fences, vortilons, vortex generators, trip strips, cuffs and other aerodynamic fixes of this type indicate that a given configuration needed some correction to provide the desired low speed handling. A properly rigged Velocity is stable in all flight modes with very few gimmicks on the wings.

#### Canard rigging

Set the angle of attack with the gauge supplied. If the curve of the gauge touches in the middle cut the wood away so that just the front and rear contacts the upper surface of the canard. Please do not decrease the angle relative to the main wings.

Some builders have assumed that by sanding the fill on the top of their canard a little flat plus reducing the canard angle of attack their plane will be faster. In reality this makes the fuselage, strake and main wing fly at a higher angle of attack at cruise slowing the aircraft about 10 knots and decreasing climb rate. In extreme cases the canard wake dumps into the strake making these Velocities about 15 knots slow! The worst is at the slow speed end of the envelope where reductions in utility and safety occur as a result of the slightly nosed down canard.

Too much nose up in the canard produces drag and makes it impossible to trim the nose down at normal cruise. A properly set canard may not have enough elevator nose down trim to fly full throttle at sea level with only one pilot. This quirk is OK because at 10,000' MSL where we should fly high aspect ratio type aircraft the indicated airspeed is much lower and the trim works. At altitude the trim puts the trailing edge of the elevator up about 5 degrees for single pilot and level at gross weight. Any plane that can reflex its flaps a little, at cruise, is faster.

#### Elevator rigging

This is tricky business. The nine hinge torque arms mounted in the canard have to be lined up so you can see through all the bolt holes at

one time. They also have to be straight forward, the right depth and 1/8" behind the trailing edge of the canard (12" behind the L.E.). If the hinge point is directly under the canard trailing edge it is geometrically impossible to get more than 15 degrees of up travel. I don't know why I mounted over 40 sets of these before I molded a jig that does it consistently correct with ease.

Assuming the elevator is hinged correctly there are still five more ways to mess it up that result in fast landings. Test of the standard winged Velocity worked best by limiting the elevators high lift potential with at least 3/8" x 42" leading edge cuffs. At 26 degrees down the gap should be .200" up to the canard trailing edge. We are just beginning to find out that the 173 winged Velocity needs all the elevator high lift device it can get. Currently we are making 173 elevator cuffs only 1/4" deep and the gap 1/4". The 173 appears to have a lot more low end potential but we don't want to push it until after we do some Alfa curve flight test on a several different ones.

All of the test canards that Dan Maher made had bare glass under the trailing edge on the back side. This rough surface stirs up the air so that more will pass through the slot and over the top of the elevator. If you have already made this part pretty just sprinkle a little sugar in the paint back there..... home made micro vortex generators. The most common elevator restrictors are the gismos we hook to them. The concentric torque tube has to be lined up with the hinge center line to prevent binding and clearance problems. The counter balance weight arm likes to hit the underside of the canard before the elevator is all the way down. It's real hard to see were it's hitting so double check that you have at least 26 degrees down travel. The trim spring bracket requires a deep cut into the trailing edge of your canard inside or it will also limit down travel. The auto pilot can do the same thing but worst. The push rod will go over center and lock the elevator in the full down position if installed and adjusted wrong.

With full aft stick check for full aileron travel. Yes, the joy stick hole in the console needs to be square.

#### Wing Sail rigging

Winglets produce thrust just like sails. When they are not sheeted in enough the plane is yaw unstable at low speed and may luff at 135 knots and 2300 rpm (the harmonic frequency of the main wing structure). When sheeted in too much, drag and side loads are too high at cruise. The correct angle of attack, toe in, on your winglets makes your plane faster at cruise and easy to handle on landing.

Making winglets taller effectively increases the wing span and aspect ratio of the main wing. This decreases top speed and roll rate but increases structural loads and climb rate.

#### Propellers

This is the most important and least understood wing on the air plane. We have some fixed pitch props that cruise faster than even the most expensive constant speed models. High tip velocities makes the last 6" do all the work. Props that don't perform are always "club" shaped and ridged at the tip. Centrifugal force is what keeps props from breaking from thrust loads so the tips can be made thin and flexible. What works best on a Velocity is a wood and/or composite prop that is somewhat like the WW1 "Simitar" ones. These new high speed versions have only a little sweep back at the tip. The structural fibers sweep towards the leading edge letting the tip twist. This way they flatten on climb and resume full pitch when off loaded at cruise. Ideally we want 2500 rpm on take off and no more than 2700 rpm level flight at altitude and full throttle. Most good fixed pitch props should deliver only about 300 rpm difference between sea level take off and full throttle at 10,000'.

Performance differences between props varies incredibly. Even two props from the same manufacturer with the same specs cut very precisely will perform slightly different. Be patient working with your prop sup-



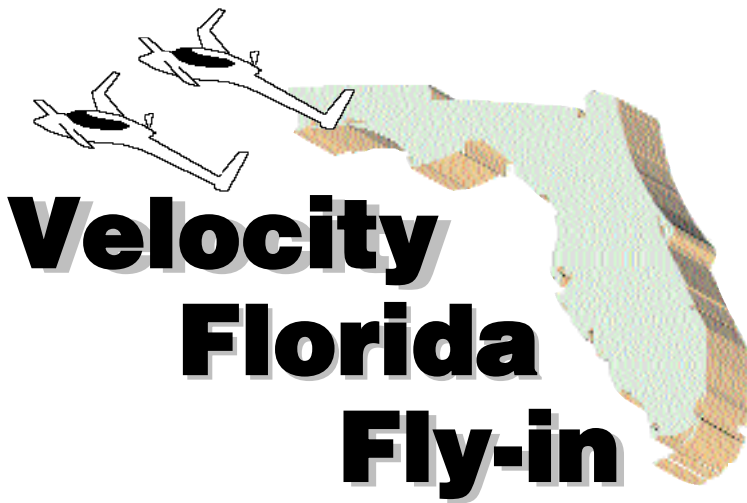

# Velocity Florida Fly-in

- **Saturday Nov 2, 1996**
- **Historic St. Augustine**
- **Airport Cookout**
- **Dinner & Speaker**
- **Builder Q&A session**

Duane Swing has planned another fun outing for Velocitys. It involves all the things I love to do; flying, meeting with old friends, making new friends, eating, and the excitement of being at an airport with a bunch of Velocitys! Here are the details:

• **Who should go:**

Anyone flying, building, or dreaming of a Velocity (and, of course, your spouse or guest).

• **When:**

**Saturday Nov 2nd and Sunday, Nov 3rd**

• **Where:**

St. Augustine Florida  
Identifier: KSGJ

• **Arrival Time at SGJ airport:**

11:00 am Saturday Nov 2nd

• **Saturday's Activity:**

- Noon **cookout** in front of the new airport terminal building courtesy of Velocity Inc.

- Afternoon open to see the oldest city in America or hang out on the beach. We will have a large van or two (courtesy of Velocity Inc.) at the airport to shuttle Velocitys without cars to the city or the Holiday Inn, etc. Other Velocitys with cars can also help out with transportation.

• **Overnight Lodging:**

- Holiday Inn at St Augustine Beach. The Holiday Inn is right on a beautiful 7 mile long sandy beach! There

are two Holiday Inns in St Augustine...make sure you go to the one at the Beach (see map).

• **Saturday Night Dinner:**

- Dinner at 7:00 pm at Holiday Inn Beach (St Augustine Beach) Florida style buffet includes: salad, grilled NY strip steak, broiled shrimp, vegetables, baked potato, rolls. Attorney Mark Ewart addressing legal concerns for experimental aircraft liability, followed by a builder's Q&A session with the Swings (factory owners).

**Cost:**

- Lodging cost @ \$55 per night per room  
- Dinner cost \$21 pp / \$10.50 kids 14 & under (includes tax & gratuity)

• **Reservations:**

- Make your own reservations ASAP but no later than October 20th! Feel free to alter your arrival and departing dates according to your own schedule when you book your reservations. Contact the Holiday Inn and specify that you are with the Velocity Group! **Call 904-471-2555** to book your room. Velocity Inc. has 20 rooms blocked off. To be sure that you get a room, call right now and book!

• ***"...but my Velocity is not finished yet"...***

Don't feel like you can only go if you are flying a Velocity. Rent a 172 or bum a ride, or God forbid, even drive! Judy and I drove to the last fly-in at Winter Haven.

**About "St. Augustine"**

The old city is a great place to walk, tour and shop. The entire downtown section has been beautifully restored, with quaint pedestrian-only streets and a central Plaza, flanked by a beautiful Cathedral. Visit the Castillo de San Marcos (original fort built by the Spanish), or any number of attractions. In the restored Spanish Quarter, colonial life is recreated in a living history museum village. The city has many historic buildings to tour, including many "Flagler Era" churches, private and public buildings (including Flagler College, built in 1888 as the Hotel Ponce de Leon). Museums are numerous, with the magnificent Lightner Museum of Victorian era collectibles, the Government House and the "Oldest House" and more. Antique collectors find lots of treasures, and there are many art galleries and unique shops. There are lots of good restaurants, even if you just want a French pastry or English tea. Scenic sight-seeing trains, horse-drawn carriages and bayfront cruises are popular ways to see St. Augustine. The Fountain of Youth, Ripley's Believe It or Not, Potter's Wax Museum and the Alligator Farm are popular attractions too. Outside the city at I-95 is a huge factory outlet mall of over 100 stores. Much too much to fill just one weekend...and we haven't even mentioned the beach!

We use self-tapping screws to hold large parts together while they cure, then remove the screws before glassing. For example, we used them to hold the side channels and center console to the fuselage while the resin/fiber mix underneath the flanges cured. After removing the screws we accomplished the prescribed lay-ups.

**Super Glue:**

Where you need to hold small parts precisely in alignment for glassing, super glue (cyanoacrylate, also known as Hot Stuff or Zap/CA) works wonders. It is much faster and is more convenient than Bondo. Used with Zip-Kicker (accelerator for cyanoacrylates, available in hobby stores) the super glue sets instantly and is surprisingly strong. Not strong enough, however, to use for anything more than holding parts while the resin cures.

**SprayLat:**

There are lots of ways to protect your Plexiglas during construction and painting. But this has to be the easiest. We inlined the windows with electrical tape, then brushed several coats of SprayLat onto the Plexiglas. When it dries it provides a protective film. Then when you want to remove it, SprayLat peels off easily. Available through Spruce.

**West System:**

When you get to the filling and

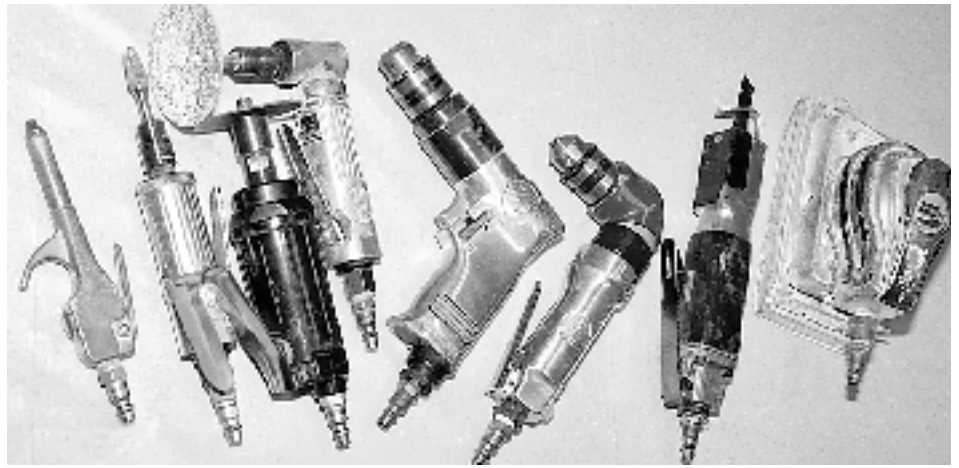

*Dave's Air Tools (in left to right order )*

sanding portion of your project you may want to consider West System 105 resin and 205 hardener in place of the Alphapoxy or Velocipoxy supplied with the kit. West has the advantage of a relatively fast cure time (about two hours), and has good sanding properties. Its available from Spruce but we got ours through the local boating store (saved a little money and it was in stock).

**Car Wax:**

A useful addition to release tape. Cured fiberglass will separate easily from any surface covered with wax. To guarantee easy removal of the cured part, before glassing just smear a thin coating of car wax on top of the mold or whatever release tape you are using.

**Belt Sander:**

This is absolutely the perfect tool for trimming and shaping fiberglass parts. But we've found it quite handy for shaping or smoothing aluminum parts as well. We used it on the above aileron trim mod.

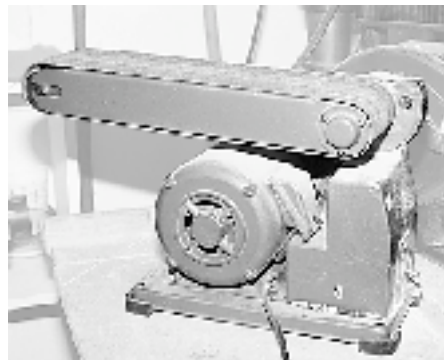

**Air Tools:**

If you have not discovered pneumatic tools, you should! Air tools are inexpensive and lightweight compared to their electric counterparts, allowing you to work in tight places that would otherwise be difficult or impossible. Because of air-cooling, they do not overheat. But they are noisy, so be sure to wear hearing protection. Most tools cost in the \$20-50 range at Harbor Freight (800-423-2567). We have found the following to be especially useful:

**Blower** - Great for quick cleanups.

**Die grinder** - We call it our dental tool, because that's just what it sounds like. The tree-shaped rotary burr (shown) is indispensable for precisely shaping and trimming glass parts and fillets.

**Cutter** - Cuts fiberglass without delaminating. Great where you don't want to cut completely through a part.

**Angle die grinder** - Gets into places the straight one will not reach. Fitted with a 3 disc (shown here), its also useful for sanding and grinding.

**Drill** - Small and powerful. Beats electric!

**Angle drill** - Gets into tight places.

**Body saw** - A handheld jigsaw fits into all kinds of tight places and cuts nearly anything. Absolutely indis-

# Builders Forum

Builders Forum is full of tips, information and letters ("material") supplied to *Velocity Views* Newsletter from individuals that are Velocity builders (or want to be builders). It is provided as "USE AT YOUR OWN RISK" material. Neither Velocity Inc. (The Velocity Factory) nor *Velocity Views* Newsletter (Lavoie Graphics & Rick Lavoie) have endorsed this material, and disclaim any liability for the use of this material. Individuals who use this material for the operation, maintenance, or construction of their homebuilt aircraft do so at their own discretion and at their own risk. Any variance from the builders manual is high risk.

*From Jim Agnew, Tampa, FL*

## Window Installation Tip

The manual tells us after micro-glassing the windows in to cut a line around the tape on the inside of the window following (as close as possible) the window cutout.

This is much easier to do if you have a single layer of duct tape on the inside of the window. Take a small flexible strip of metal (I used a 6" stainless steel rule 1/2" wide) and shine a bright light in from the outside thru the frame. You can clearly see where the frame ends and the outside duct tape starts. Just line your rule up with the shadow and take your time following the line. Its a lot better than guessing!

•••••

*From Cory Howe, Little Rock, AR*

## Applying Micro Tip and more...

Howdy, my name is Cory Howe from Little Rock, AR and I have been building a 173 RG Elite for about eighteen months now. It has been a very enjoyable and exciting project. I am coming down to the wire on the completion of this project or should I say the wiring. All of the fiberglassing and fill work is done. Everything has been primed and many parts ready for paint. The engine was installed about a month ago and many of the electrical pieces are now being mounted in place.

I am always anxious about getting the Velocity Views because of the things I learn from other builders. In that sense I am writing about a few things that I wish I had been more knowledgeable about a few months ago.

1.) One of the problems about applying micro to a surface, such as the wings, is the fact that the micro wants to curl up around the trowel instead of sticking to the surface when it is being applied. A good



friend and fellow velocity builder Mike Pollock from Dallas gave me a tip he got from Dick Rutan. The tip is to wet the wing surface with pure Alphapoxy with a dampened rag before applying the micro. You only need enough Alphapoxy to dampen the surface and any more would just be wasted weight in epoxy. With the surface wet the micro adheres extremely well and eliminates the problem of micro curling up and not sticking to the fiberglass surface.

2.) In retrospect, I would have been more cautious about the amount of micro I applied in the area of the ailerons. I had to add additional weight onto the aileron for balancing purposes.

3.) When installing the pulleys for the main gear retract system try to install them as low as possible. In the Elite version the aileron bell-crank is installed just above the area where the main hydraulic cylinder arm and cables are moving. The lower the pulleys are the lower the cables are which means you have more clearance for the movement of the aileron bell-crank. That is a good thing.

4.) When installing the top strake to the fuselage there was one thing I neglected to do which had to be fixed after the fact. In the area of the top

strake next to the fuselage where the fuel tank resides below (or in other words about the aft 1/3 of the top strake next to the fuselage) I would recommend that the foam be removed between the inner and outer skin and filled with wet micro-glass or flox. This should eliminate one possible leak point.

5.) When installing the wheel well try to keep as much room as possible between the aft fuel bulkhead and the wheel well. Having more distance will allow for an easier time sealing the inside of the tanks with epoxy. I did not have much room and it was difficult to get epoxy in that area.

6.) If you are installing a Franklin engine in an Elite you may have

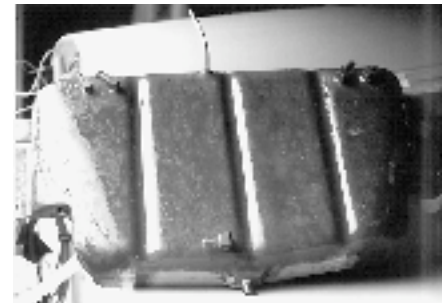

found that the engine mount bolts interfere with the sump tank. I had to cut my sump tank open with a band saw and re-glass it to allow

space for the engine mount bolts.  
(See picture)

7.) In starting the interior of the plane I came across an aircraft seat upholstery shop. They built four of the most beautiful seats I have ever seen. They are made from a special vinyl looks and feels just like leather without the cost. This covering has passed the FAA FAR #25.853 and California Flammability Regulation 117-75 flammability tests. It is also stain, abrasion, and mildew resistant.



Not only do they look and feel good but they are extremely comfortable and come in an assortment of 20 colors. If you would like more information please call Horizon Enterprises at 501-835-5066.

I am looking forward to reading more comments and ideas in the upcoming Velocity Views.

.....



**VELOCITY  
VIEWS**

**If your label reads  
"Paid thru Vol 8", then  
this is your last  
newsletter unless you  
renew by  
December 20th.  
See Page 19.**

*From Dave Black, Woodbridge, VA*  
**Mods Antennas & Tools**

**Concentric Torque Tube Bearing:**



In Volume 4, I mentioned all the advantages of my concentric torque-tube mod but failed to give the bearing size needed. I apologize. The Fafnir KP6A (available from Spruce) will do nicely. Fasten in place with AN6-15 bolt, MS 20142-6 stop nut, and four thick washers.

**Strake Top Reinforcement:**



Just prior to painting we found many little dents in our strake surface. We determined these had been made by elbows and other hard objects during the process of construction. To end this damage we decided to toughen the top strake skin. We laid on a single ply of carbon BID, since it is about six times as rigid as the equivalent weight glass. But that may have been overkill. One ply of fine glass BID should do the trick. Be sure to sand through the primer down to the glass. The BID should overlap the join-line at the leading edge.

**Aileron Trim Mod:**

In volume 5, Bill Wade showed an improved aileron trim actuator. Bills system replaced the slippage-prone motor and string system with one built around the MAC-8A servo. I was intrigued by Bills design, but in building mine chose to eliminate the

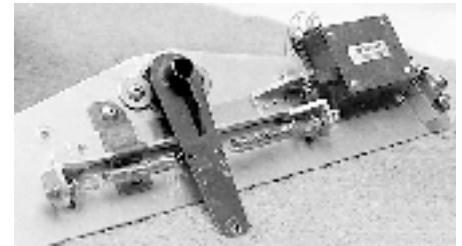

string and pulley entirely. My 8A servo is mounted directly to the aileron control bracket, where it slides an aluminum bar. On the left, the bar is held in alignment by a custom-made 3BID fiberglass strap. Both ends of the bar have an L-bracket to which is attached an eye bolt with locknut. The original springs connect the eye bolts to the bell crank. This new system retains the non-slip advantage of Bills system, but also permits accurate tensioning of the springs. It should be simple to center the servos range and adjust spring force. And it operates very smoothly.

**Antennas:**

In previous issues, we noted the antennas originally installed in our Velocity wings and winglets were plagued by a laundry list of design and construction flaws. After thorough testing and gnashing of teeth, we determined the old antennas would have to be completely removed.

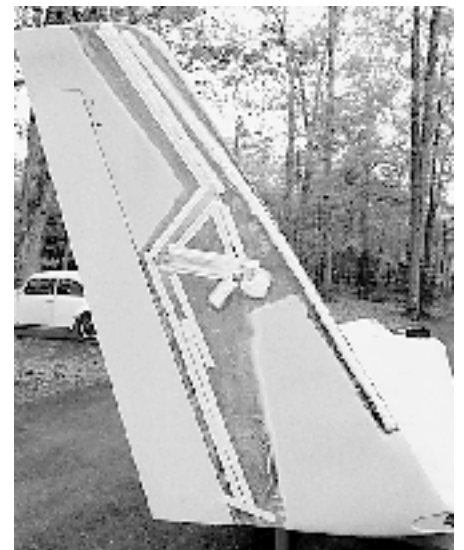

Using our MFJ Antenna Analyzer, we easily located the defective antennas along the leading edge of the outer winglet skins. After sanding off the primer and fill we used our rotary cutter to slice through the skin. We peeled the glass

from the foam and pulled out all pieces of the original antenna, along with its cable. We were able to pull the old cable completely out of the winglet through the position light mounting hole. To install the new cable, we drilled a 1/4 hole through the foam just inside the winglet leading edge. Where the old antennas and cables had been removed, we filled the gashes with bubbles, sanded, and glassed over with 3 fine BID.

Because carbon fiber detunes antennas just as aluminum does, we feared we would be forced to remove the carbon reinforcement from the entire rudder line of our winglets. However testing showed that if we carefully positioned our Sportcraft antennas directly on top of the carbon fiber, we could nearly eliminate the adverse effects. We fixed the antennas in place right on top of the existing glass skin using a moist resin/ fiber mix. We held everything in position with rivets and masking tape until the resin cured (photo). Then with 1 fine BID, we glassed over the Sportcraft antennas. When cured, we filled and sanded until smooth.

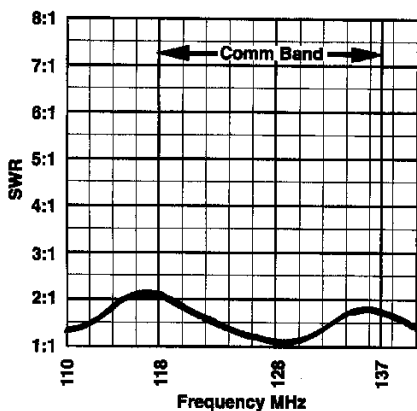

The above SWR chart shows the results of our finished installation (For comparison, see the SWR plots of our original antennas in Volume 4). While not perfect, our SWR remains below 2:1 across all but the very bottom of the Comm band. To have reduced the SWR further would have required rebuilding the winglets minus the carbon.

The number of calls we have received concerning dysfunctional antennas shows our antenna experi-

ence is all too common. Our advice: Spend the \$50 or \$120 for Sportcraft or AAE antennas, or build Larry Coens antenna (volume 5). But no matter what antennas you use, SWR test your installation before you glass everything permanently in place. Its easy to make adjustments at this stage, and it may save you lots of headaches later.

#### Advice for New Builders:

During my two-year building process, I have learned a few things which I hope may be of value to new Velocity builders.

#### Get Help:

First, home builders as a group are the friendliest and most helpful bunch of folks Ive met. Every builder and potential builder I have spoken with has freely offered valuable suggestions and tips. Thus I recommend you not build your Velocity in isolation. Talk to other builders. Join the EAA (800-843-3612) and take advantage of the expertise offered by their Technical Counselors. Subscribe to the Central States Newsletter (9283 Lindbergh Blvd, Olmsted Falls, OH 44138-2407) for information on canard aircraft. If you're on the Internet, keep an eye on [rec.aviation.homebuilt](http://rec.aviation.homebuilt). If you are not sure of something, call the factory — they are always helpful. And of course, renew your subscription to Velocity Views.

#### When to Assemble Wings:

Beginning your kit construction with the wings will give you an immediate sense of accomplishment, but I believe there are good reasons to delay this particular phase of construction:

- 1) The completed wings are awkward and subject to damage. They must be kept protected from the elements. If you are building in a 25 x 35 area, this is no problem. But for most builders, space is at a premium. On the other hand, the unassembled blue foam can be stored in any cubby-hole, where space and damage are not an issue.
- 2) New builders may not have experience with fiberglass construction. They would build lighter, stronger

wings if they sharpen their fiberglass skills first by working on the smaller, easier to manage lay-ups found within the fuselage.

Thus I suggest delaying wing and canard construction as long as possible. The first time you actually need your wings is when you are ready to close the strakes. And for that operation, the winglets need not be installed on the wings. If you leave the winglets off until you actually need them, the wings will be lots easier to handle and store, and there's that much less to carry around and get damaged while you are working on the strakes.

#### Just in Time:

Don't build ANYTHING until you actually need it. That statement generalizes the advice above. Looking back, we could have saved substantial time and effort if we had followed that philosophy throughout the project. We have discovered time and again that a subassembly or part we built ahead of time required modifications by the time we wanted to install it. There are several reasons for this: Once you are ready to install a particular subassembly, you have a very good idea how it fits into the project. You may have come up with a better way to build it. Or make it fit better. Maybe the factory has issued an improvement or KPC. Whatever the case, there appears little advantage in getting too far ahead of yourself. Or so it seems to me.

#### Helpful Stuff:

You can build your Velocity with common supplies and shop tools. However a few additions can greatly simplify your construction process.

#### Self-Tapping Screws:



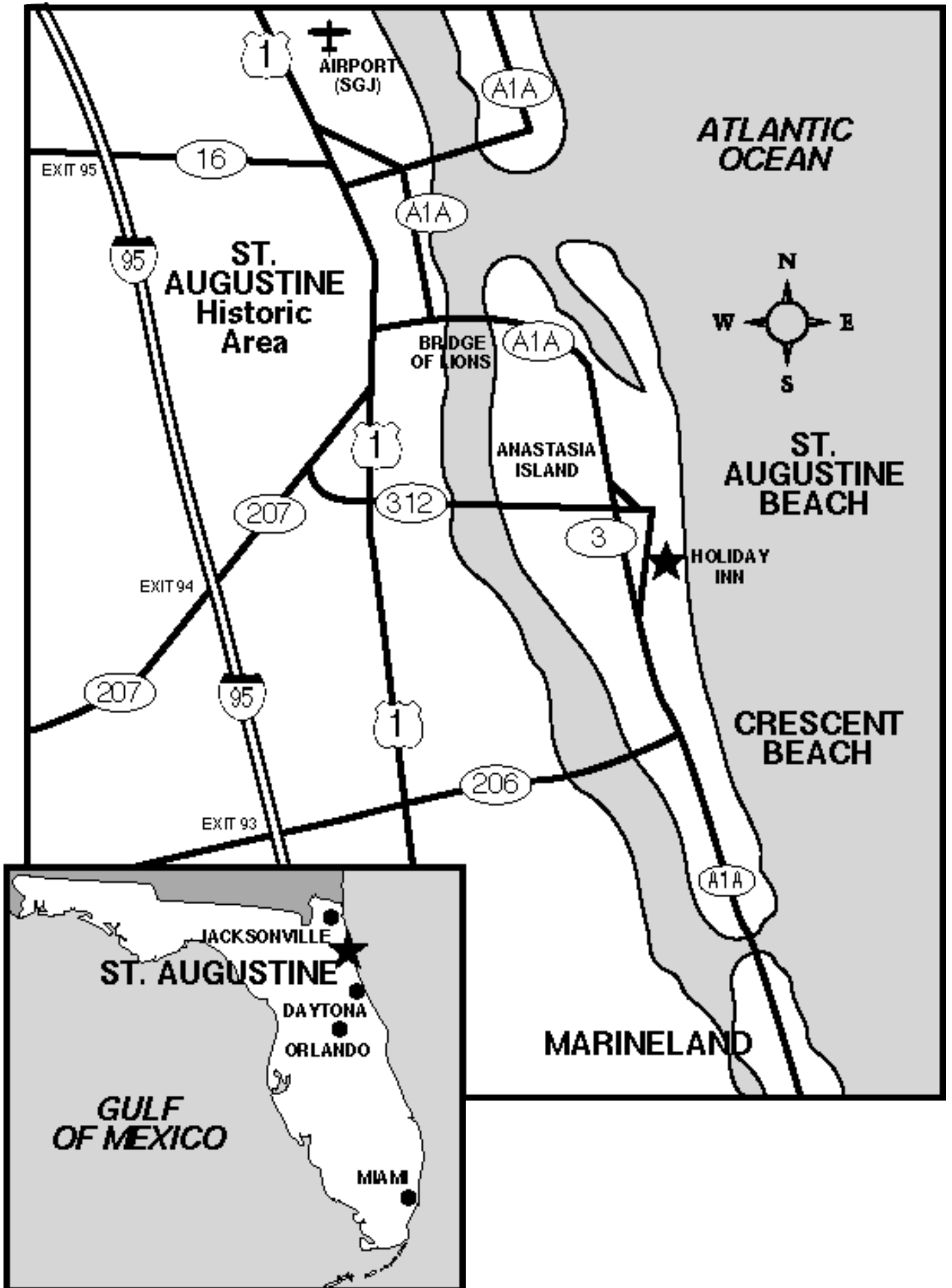

**Time to Renew your  
Subscription to  
Velocity Views**

**See invoice on page 21**

**If you do not renew  
by December 20, 1996,  
your name will be  
deleted from the mail-  
ing list. No invoice or  
notice will be mailed!**

pensable.

Orbital sander - Useful for removing rough edges from cured glass or for preparing a cured surface for an additional lay-up. Not for finish sanding!

Air compressor - Most air tools require 4-10 cubic feet per minute of air at 90 pounds pressure. A 1-horsepower compressor simply can not keep up with the tools. Our tried-and-true 1-hp compressor bought the farm only one month into our Velocity project. We replaced it with a 5-hp compressor we discovered at Sams Club for \$300. It has served us splendidly through our entire building process.

You may contact me at (703)590-2221 or asterisk@idsonline.com .

.....

*From Alan Shaw, Dynamic Wing  
Company, Melbourne Florida  
shaw.wingco@worldnet.att.net  
(407) 253-1975 fax 3868*

**Antennas, Canard, Elevator, Wing  
Propellers, Information & Tips**

Antennas:

At the Wing Co. we have always tested our antennas. In the past we just did conductivity test but for over one year now we have also been testing the percentage of signal reflected back to our test transmitter. Having made over 200 different test

readings, we have found the basic dipole antennas very adequate for most VFR aircraft uses. However their efficiency is mostly in the center of the band with wide variations particularly at the extreme high and low frequencies. This is surprising considering that the aircraft AM band is relatively narrow.

The one set of "Sportcraft Antennas" that we installed proved to be the most efficient particularly at the high and low frequencies. This type of efficiency means that communicating with "Center" at much greater range is possible. Also transmission from the ground to an airport departure control 20 miles away is possible. I have to agree with David Black that the small expense of these better antennas are well worth it. For this reason we are changing our standard com antenna installation to Bob Srcher's Sportcraft Antennas.

Canard aerodynamics

The "EASY" type configuration is complex to predict what different variations will produce. The Velocity is a versatile and forgiving performer yet we still don't fully understand how we got so lucky. At Oshkosh '79 I had the fortunate opportunity of having a 30 minute one on one conversation with Burt Rutan while sitting under the wing of his Defiant. Burt made it clear that the basic rule of thumb was to keep the wing loading on the canard double that of the main wing but eluded that there were other factors at play.

For the last 17 years I have built and tested scores of models; conventional, canard, three wing, etc. and of course real Velocities. What I have learned is that you can stretch that first rule of thumb by changing the other factors and get better performance but still retain stable characteristics. The rest of the factors and their average ratios of differentiation fore to aft look like this:

- 1 loading per unit area 2 to 1 (Burt's)
- 2 angle of attack 2.5 degrees to 0
- 3 camber radius 2 to 1
- 4 aspect ratio 2 to 1
- 5 wing area 1 to 5
- 6 coefficient of lift 2 to 1

7 gremlin odds 10 to 1 (that any change will make things worst)

The general rule is if you lessen the difference between the front and rear wing by one factor you have to increase it by another to retain the same stability. Infinite different combinations of different ratios between these factors are mathematically possible. What the designer looks for are combinations that give a compromise between stability and performance that is acceptable within certain flight parameters. Conventional aircraft violate factors #1 & #2 when they try to fly too slow. That's why they stall and spin. The designers have limited the flight envelope to maintain stability. For anything but an aerobatic aircraft I find this compromise unacceptable and morbidly appalling.

Applied to "EASY" types this differential wing principle is quite helpful. For example the common solution for a canard that feels unstable at low speeds and may deep stall is to cut some off the tips. Sure this increases the loading differential but it decreases the aspect ratio differential. At the given low airspeed it may or may not be more stable but it can't fly that slow anymore so who will ever know? The problem may be in the airfoil and twist of the main wing or the toe in and inward tilt of the winglets. Roll and yaw instabilities always progress into pitch instabilities (and pitching can manifest roll and yaw). If the main wing is OK then perhaps the solution to this problem is to make a new canard with less cord, more camber and a high lift device type elevator. This way you can take off and land short and slow. It also may make it possible to load big people or little people in the nose and still fly stable at all speeds.

The Velocity has a much wider loading and speed range than previous canards because of the size of the elevators and the strakes. At 40% (the norm is 25%) of the canard's total cord the elevators became a trim flap form of variable geometry. At approx. 50% of the total main wing area the strakes lower the aspect ratio and raise the coefficient of lift at landing

# Kit Plans Changes “KPCs”



*Note: Check the date at the bottom of your page. If it matches the “Date of Change” shown in the KPC, your manual has already been corrected.*

## **KPC 029**

Affects: All Standard Wing Velocities  
Manual Section: 4.4.4  
Date of Change: 9 July, 1996

Change the last part of the first paragraph to read: “Measure and mark 77” outboard of this center point and square off the canard ends.”

## **KPC 030**

Affects: All Velocities  
Manual Section: 4.6.1  
Date of Change: 15 Sept, 1996

Change the gap width in Figure 4-37 from .020 to .200”. (Note: the gap can be up to .250”)

## **KPC 031**

Affects: All Velocities with canted instrument panel  
Manual Section: Figure 5-1  
Date of Change: 1 Sept, 1996

Note that the copilot side of the panel is 1-3/4” aft of the pilot side because of the canted portion.

## **KPC 032**

Affects: All RG’s  
Manual Section: 9.5.3, Main Gear  
Date of Change: 1 July, 1996

The Figure shows the upper main gear door attachment tab being screwed into the gear leg, but the text says to glass the tab on. Delete the section of text and follow the Figure.

## **KPC 033**

Affects: All RG’s  
Manual Section: 9.6.3, Hydraulic

Plumbing Schematic  
Date of Change: 1 July, 1996

Change the part numbers of the elbow, sleeve, and nut coming out of the dump valve to:  
AN 822-4-4D  
AN 818-4D  
AN 819-4D

## **KPC 034**

Affects: All Elites with speed brake  
Manual Section: FG-10.2.1, RG-10.2.4  
Date of Change: 9 July, 1996

Change the size of the pilot side aluminum bar for the seat hardpoint from 6.5” to 5.5” long.

## **KPC 035**

Affects: All RG’s  
Manual Section: 12.3.1 page 12-11 and page 12-13  
Date of Change: 1 July, 1996

Change the angle of the aileron bellcrank to 10 degrees from vertical.

*Note: a postcard was mailed to all builders for KPC 035*

## **KPC 036**

Affects: All 173’s  
Manual Section: FG-14.3, RG-14.4 (Outboard Strake Reinforcement)  
Date of Change: 1 July, 1996

Increase the size of the Triax strips to 4” x 29”.

## **KPC 037**

Affects: All RG’s  
Manual Section: 14.3.1 Figure 14-15  
Date of Change: 9 July, 1996

The inboard strake bulkhead that parallels the fuselage is erroneously shown as two bulkheads. Change the name of “J” to “E”. It is one bulkhead.

## **KPC 038**

Affects: All RG’s  
Manual Section: 14.5.1 Figure 14-29  
Date of Change: 15 Sept, 1996

Change the front bottom sump tank fitting to 1/4” pipe, 3/8” hose

## **KPC 039**

Affects: All Velocities  
Manual Section: 17.1.2  
Date of Change: 15 Sept, 1996

Change paragraph four to read: “Position the engine so that the center of the prop extension is actually 3/8”-1/2” above the center of the cowl outlet. This is because the rubber mounts will sag after a few hours of operation. Also rotate the pilot’s side of the engine down a 1/4” or so to help with cowl clearance. If you don’t do this, the top of the cylinder will contact the top cowl.”

## **KPC 040**

Affects: All Velocities  
Manual Section: 20.2.10  
Pages 20-17,18  
Date of Change: Delete references to tilting the engine up 1 degree. No shims are needed between the mount and the firewall.

## **KPC 041**

Affects: All RG’s  
Manual Section: 17.5 Figure 17-12, Heater Valve  
Date of Change: 1 July, 1996

This figure is supposed to be a full-size template of the heater valve, but it magically got shrunk. It needs to be enlarged to 124%, or add 3/8” to the top, left, and right sides and 1/2” to the bottom. (The top refers to the top of the page)

## **KPC 042**

Affects: All Velocities  
Manual Section: Elites: 10.3.4, Non-Elites 10.2.6  
Date of Change: 1 July, 1996

The rear view in the control stick assembly figure (Elites: 10-14, Non-Elites: 10-12) shows the bolt attaching the control stick to the aileron torque tube going the wrong direction. The head of the bolt should be on the pilot side. The side view shows it correctly. Also, there is no sleeve over the control stick itself. The molded handgrip supplied in the kit merely slides over the steel stick.



plier in getting yours fine tuned by them. Please don't try and modify propellers yourself. The propeller is the most important wing on the airplane.

#### Wing construction

First time builders make solid core wings that are reliably strong and fairly consistent in contour. Hollow wings built from molded skins and fitted ribs vary in strength and camber even with experienced builders. Ribs are hard to fit and bond to. Composite structures that look like metal structures are usually an example of improper engineering application.

The main concern with solid core is to take your time doing the jiggling, alignments and glass prep. Even if you used peel ply always coarse sand fiberglass before making secondary bonds.

Topics coming up in future issues: Fill, sand, prime and paint, Carbon, Nitrogen filters for cabin oxygen.

.....

From Dave Black, Woodbridge VA

I applaud Alan Shaw's decision to switch from RST-style antennas to SportCraft (Bob Archer) antennas in the wings he builds. This should make builders most happy.

Still I must disagree with some things Alan said. Conductivity testing tells us only that an antenna is connected, nothing at all about how well it works. Percent Reflected Power is much more to the point. As its name implies, this measurement shows what portion of the transmitter's power bounces off some obstruction and returns to the transmitter. It is Reflected Power which damages your transmitter. By the way, Percent Reflected and SWR are really two ways of expressing the same thing. The translation is as follows:

SWR	% Reflected
1:1	0%
2:1	11%
3:1	25%
4:1	36%
6:1	51%

Of course, the lower the SWR (or %

Reflected) the better. Anything above 2:1 SWR is generally considered unacceptable.

"Over 200 different test readings" sounds impressive, but it means Alan measured only three specific frequencies for each antenna. Yet SWR can vary greatly within only a few megahertz. Thus it typically requires around 20 individual SWR measurements per antenna to give a realistic picture of its overall performance (see chart A). Alan's measurements do bear out his obser-

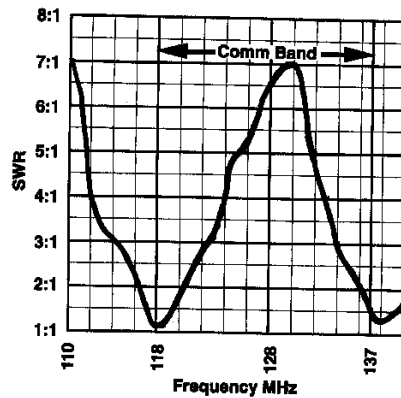

Chart A) SWR plot of RST-style antenna displays wide variation distinctive of a serious mismatch. Note the SWR is below 2:1 only in narrow frequency ranges. This antenna passed the conductivity test but is useless over most of the Comm band.

vation of "wide variations" in RST-style antennas, however. Such wide, almost random, variations are to be expected from mismatched antennas. Significantly, no RST-style antenna proved acceptable over the full Comm band — or even at all three frequencies Alan tested. Therefore I must take exception with Alan's assumption that RST-style antennas are "very adequate."

The best RST style antenna I've personally examined had an SWR ranging between 1.8:1 and 3.5:1. This antenna worked, but hardly performed as well as an antenna should. Others have been far worse. One pair Alan tested reached an almost unheard-of 8:1 SWR. That's 60% of the power the transmitter sends to the antenna bouncing all the way back into the transmitter! You know this transmitter is going to have a hard, short life. A dozen builders

with RST-style antennas have come to me with reports of reduced communication range. Two builders even told of communication ranges of five miles where it should have been over 100.

With careful adjusting you can make an RST antenna work at specific frequencies, but never as well as a properly matched antenna. The Bob Archer antennas cost about \$45 more than the RST-style, but they WORK very well across the entire Comm band (see chart B). They are definitely "most efficient."

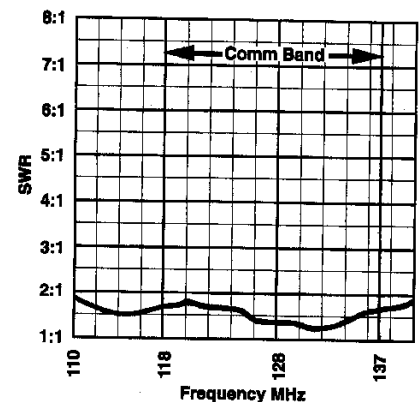

Chart B) SWR remains below 2:1 across the entire Comm band on this Bob Archer (SportCraft) antenna. Such a low, flat SWR plot is representative of a properly functioning antenna. It works well on all frequencies.

Many builders recognize the false economy in installing \$5 antennas in their \$100,000 plane. Keep in mind it is simpler to add an antenna to a finished wing or fuselage than to remove a faulty antenna and replace it. For this reason, I'd use Bob Archer antennas in each location, or install no antenna at all.

I remain amazed at the fascination among aircraft home builders with RST-style antennas. Prior to my involvement with home built airplanes, I had never heard of mismatched antennas such as these being used intentionally in any radio application. The half-dozen radio engineers I spoke with about unmatched antennas all ridiculed the idea. Without proper impedance matching, an antenna simply can not perform properly. Period. Not only will it transmit and receive a weaker

# Short Circuit



by Martin Hadley



## Compass Calibration

One item that is often taken for granted in an airplane is the magnetic 'wet', or 'whiskey', compass. All too often its accuracy goes unchecked or calibrated.

Checking and calibration of this instrument is not hard to do. At most public airports in the country, a compass 'rose' has been painted on ramp space somewhere either by the controlling agency or by the international organization of flying women known as the Ninety Nines. (Most by the latter!) Locate a field close to

you that has one and take a friend with you to help.

Besides the friend that is going to help you line up properly on the compass 'rose', you will need a non-magnetic screwdriver, usually made from brass, a pad of paper, and something to write with.

First, check your compass north, south, east, and west readings by lining up your aircraft properly on the compass 'rose' and record your compass readings. Normally, for example, if your compass readings are 3 degrees right of north (or 003) you will be 3 degrees right of south (or 183). The same applies for east and west. In any case, always adjust your east/west error first! (This adjustment will effect your north/south reading dramatically if there is a big error to correct.) If there is no error in east/west, then adjust the north/south.

After you have rechecked all four headings one more time, and made whatever fine adjustments that might have been needed, you need to check and record your compass readings on 30 degree increments of the compass (i.e. 000, 030, 060, 090, 120,

etc.) The headings that you record are the numbers that go on your compass correction card. (As required by FAR 23.1547)

Now for those unexpected problems! Once in a while you will get readings such as East (087) and West (273). Instead of a consistent error to the right or left of heading, it tends to favor a hemisphere. This type of reading is usually cause by something in the cockpit effecting the magnetic compass. First of all, get that magnetic Phillips head screwdriver out of the glove box, or side pocket, and replace it with a non-magnetic type! Do you have a pocket screwdriver with one of those little magnets on the end in you shirt pocket? Throw it in the back of the plane! (Believe it or not, even the smallest magnets within 2 - 3 feet of a compass can effect it.)

Now check the instrument panel. What type of screws are in the instruments, holding the glare shield down, and what other items of steel are within close proximity of the compass? Those of you that have flown the older Mooneys will

*Continued on next page*

## Safety Corner

*Continued from page 6*

### Density Altitude and Its Effect on Take-Off Distance

We have had a couple of close calls and one overrun when a take-off was made in high density conditions. How can we easily determine the take-off distance needed when we are faced with the possibility of a high density altitude take-off?

The first step is to determine just what the density altitude is. The old E-6B computers would give us a good idea of density altitude given the pressure altitude and temperature. What if we don't have an E-6B handy? File this formula away in a convenient place for reference if needed:

Step 1: Take field elevation X .0054

Step 2: 59 - (Step 1)

Step 3: (Actual temp in °F) -

(Step 2)

Step 4: (Step 3) X 66

Step 5: (Step 4) + (Field Elevation) = Density Altitude

As a rule of thumb, add 400 feet of additional take-off roll for each 1000 feet of density altitude.

Example:

Airport Elevation = 5000 ft.

Outside air temp. = 80°F (temp. on the runway)

Step 1: 5000 X .0054 = 27

Step 2: 59 - 27 = 32

Step 3: 80°F - 32 = 48

Step 4: 48 X 66 = 3168

Step 5: 3168 + 5000 = 8168 Feet Density Altitude

At GROSS the standard Velocity will take about 1400 feet to rotate at standard temperature of 59°F. So-o-o-o, if our density altitude is 8168 feet, our take-off roll will be INCREASED by 8168 X .400 = 3267 feet. If we add the 3267 feet to the 1400, we get 4667 feet. You may need to add even more if your airplane has a high time

engine (less power), a cruise propeller, or - for whatever reason - would take more than 1400 feet of take-off roll at gross at S.L. on a 59°F day. On the other hand, if you have tested your airplane at various high density altitude and find performance better than the example above, your knowledge would supersede anything I say here. This would be especially true if you were using a constant speed prop in place of the fixed pitch.

What I am trying to say is to not treat density altitude lightly. This can be a serious problem. If you find yourself in a situation where density altitude may be a problem try a take-off with a light load. If this works out OK, add some weight and try it again. Work your way up to the maximum weight you plan to carry instead of all at once. Remember to leave yourself some margin for error and don't take unnecessary risks.

*Duane*

find lots of neat stuff that will save you hours of building time. I have found that the Swings offer the best prices on just about anything they put in that catalog.

Also, if you are just starting out, I recommend that you sign up for the two composite workshops offered by Ron Alexander (formerly President of Alexander Aeroplane - now Spruce East). He offers both a beginner and an advanced composite 2 day course. Call 1-800-967-5746 to get their workshop flyer mailed or faxed to you. Also EAA sells a composite video that goes over the basics of a layup. And finally, and most important, sit down and go through all the Velocity videos before you start. This will give you a good foundation and help you with all the new buzz words like "drill and tap". Also, go ahead and buy the fuselage cradle that was described in volume 3 page 31. It saves lots of time and allows you to level the fuselage perfect every time. It was the best \$150 I spent. I am still using it to test my gear system.

If all goes well, I should be finished with the glass work by mid November, and my goal is to be flying by January '97. I have about 1350 hours to date, and about 350 hours to go. I am working like a mad man possessed to catch up with John Vukos (now flying) and Dave Black (almost flying). I started my Velocity RG in April 1995. For those of you coming to the Florida Fly-in (see page 10), anyone interested in seeing my progress will be invited to my garage! My new Franklin engine should be here then as well, not to mention my instrument panel (by that avionics wonder Martin Hadley). Hope to see many of you in St. Augustine November 2nd!

•••••

*From Jim Willisie, Palm Harbor, FL*  
**Elite seat hard point tip, jacks, \* cylinder/control arm shield**

Since I have appreciated and used many of the ideas sent in by other builders I guess it's about time I shared some of my own discoveries. While some may be common knowledge to those in the business or

ahead of me on their projects, they were new to me and may help some newer builders.

1. MISC. The instructions say to be careful to NOT bow out the sides while installing the bulkheads, however, I found that my top and bottom where not the same. If the bulkheads and dash appear consistently wide at the appropriate locations, then maybe a little forced bowing is desirable. Double check the bottom with the top and bolt some cross braces to the side flanges to hold snug equal widths.

- Making accurate marks on the rough inside areas of the fuselage is a lot easier using masking tape.
- I like the little round bubble levels rather than line levels (checks all directions at once). I even added one to the back end of my drill for drilling vertical holes.

2. Don't bother to cut a lot of little LAY-UP pieces. You'll waste cloth and have twice as many frayed edges. It's easier to estimate your total needs and wet out one large piece. Now you'll only make half as many cuts since the last cut is the edge of the next piece. It's also easier to squeegee. I'm assuming everyone knows to do all this on double folded 4mil plastic sheeting and to cut the top layer with the glass.

3. When building FLANGES around a small or narrow piece, it's easier to cover the whole thing rather than just the edges, i.e. to make a 4 bid flange you cut 16 pieces that butt together at the corners and the space saved in the center may only be only an inch or so. Just cut 4 large pieces and cover the entire piece.

Combined with 2 above, 16 cuts become 4 and no edges to trim. (Elite keel hatch, landing light, nose gear doors, etc.)

4. I spent a lot of time and money building a fancy rolling steel framed WORKBENCH for the plane. Don't bother, since it's only needed a few weeks while building the bulkheads and installing the center spar. Once they're in you'll be raising the plane

to do the gear. A sheet of plywood or particleboard on the floor will do. If you insist on a table, try an old bed frame and some even have wheels.

When you're ready to raise it, 6 cement blocks will work. Place 2 vertically end to end (plus a piece of foam) at the spar ends and use the other 2 on the front with a board to make a bridge to hold the nose up. Brace it all with foam etc. for a little more stability.

5. I liked the hydraulic JACKS idea but made mine out of boxed steel stock. A 12" base and a 4" top piece

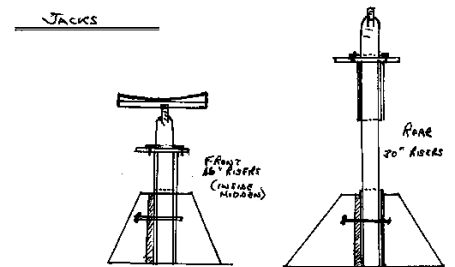

slide over a slightly smaller boxed steel center piece (riser). The riser can be adjusted for any plane (my 173 needed 30" risers at the spar ends for changing the wheels). The top piece has a 4-inch welded cap that the jack bolts to. The riser, outer base and the wood feet are connected by a single bolt and butterfly nut (additional holes can be drilled in the riser for even more adjustments).

6. SEAT HARDPOINTS the easy way. No more bent over drilling and tapping (or right angle drilling on the rear seats). No more holes through the skin. No more %@#\* future alignment problems.

- Pre-drill and tap the hardpoints
- Connect the H/Ps to the front seat

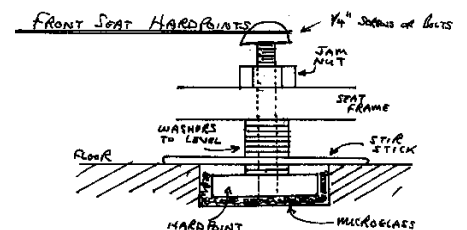

rails or rear seat angles using 1/4" bolts with a jam nut on top. Add washers and a drilled stir stick between the H/P and seat frame. The



# Safety Corner

Accident & Incident Reports,  
Maintenance & Service Difficulties

## Accidents & Incidents

There is nothing more difficult for me to write about than the information regarding accidents in the Velocity. Not only does it bring back the memories but causes me to wonder if giving you this information does anyone any good. I have to conclude that we all benefit by looking at the misfortune of our fellow

Velocity pilots and, perhaps, can learn from these experiences.

Since the last newsletter, we have had no less than three accidents/incidents that resulted in off field landings, one of which was fatal to fellow pilot and friend Robert Van Horn. Bob was early in his test flying period when he experienced a flexible oil line failure up near the oil cooler.

This time he was fortunate in finding an airport below him and made a successful landing. He called me and told me his mechanic friend had insisted he install the flexible hose, which was apparently a low pressure hose, and that it had ruptured. A few days later, according to the FAA report, an oil line in the engine compartment blew causing smoke to fill the interior and Bob was unable to make it to the airport and struck a power pole killing him. We don't know if the same type lines were used in the engine compartment or not, fire destroyed all evidence, we

*Continued on next page*

## Factory News

*Continued from page 4*

### CRYING WOLF

I just got a call from one of the engine overhaul shops in our area, Don George Aircraft Engines. Don is fed up with Velocity builders who are having problems with his engines and blame him for these problems. He takes a very serious position regarding reported problems and will send one of his mechanics, or go himself, to check out any reported difficulty. One of his pet peeves is the re-installation of the intake tubes after modification. It is easy to get them installed with the "O" rings not properly seated. This causes the engine to run very lean and rough at idle. In flight this can cause serious cylinder damage. Other problems are in the position of the fuel spider and the necessity of moving to a location less prone to heat. Don reports a customer complaint of hard starting and poor idle. His investigation indicated all four fuel lines to the injector nozzles were only finger tight. Other complaints involve oil leakage from the front oil seal in the crankshaft. Investigation indicated a kinked oil vent line causing back pressure resulting in oil being forced out the front seal. Another rough idle report was traced to an improperly installed shuttle valve in the stand-by vacuum system. He has also investigated a

Velocity complaint that was traced to spark plugs only finger tight. On and on the story goes.

I have known Don since I came to Florida and have found him not only a good engine mechanic but also very serious about good quality work. He has gone out of his way to take care of his customers, only, in some cases, to be blamed for poor quality work. I think what we have done here is shoot ourselves in the foot. We have cried wolf so often that Don no longer wants to do work on Velocity engines. This is a shame. The shame, however, is not his but ours.

### ARE WE HAVING FUN YET

This past Saturday and Sunday, Bonnie and I went on a church choir retreat at a place here in Florida called River Ranch. River Ranch is a self contained resort complete with motel type rooms, golf, tennis, horse-back riding, hunting, skeet shooting, swimming, and a variety of other activities. Right in the middle is this 5000 foot paved airstrip. Guess how Bonnie and I got to River Ranch. Because I was the only choir member to have an airplane, I decided to offer rides free to anyone who would show up during our "open" time. In order to provide enough gas to get to and from River Ranch, plus what I would need for the rides, I left Sebastian with about 60 gallons of fuel on board. The fuel tanks at River

Ranch were not in use during our stay. This 360 lbs. of fuel, plus my 200 lbs., left me with about a 450 lb. limit for the three seats. Let me now caution you to disbelieve any claims your passengers make about how much they weigh. On one trip, a mother and her two daughters had to weigh at least 250 lb. each. Singing in the choir will do this to you. Watching them get into and out of the Elite was a trip in itself. Our little 180 HP Elite struggled into the air each time without a hint of trouble in spite of the 93 degree heat. Cylinder head temperature would approach 405 degrees on the climb and then back off to about 390 once level. Oil temperature would go up to 230 degrees in the climb and then back to 200 degrees when leveled out. Up and down, up and down we went for several hours until their "cup runneth over"; I was about dead. It's not easy to feel comfortable flying with a bunch of choir members who are singing "Nearer My God To Thee" each time the tires left the runway. This is, however, why we build and fly our airplanes. The comments made by those who have never seen anything like a Velocity were worth all the sweat and tears involved. Don't give up friends, there is a rainbow out there somewhere.

*Duane*

## 1996 Index for Velocity Views Articles

I polled a few subscribers and nobody seemed to really care about getting the index of articles (see Volume 4 page 28 for 1995 index of articles). Since it takes up 3 pages, I decided not to publish it. Thus if anyone wants a copy, it is free to subscribers in good standing. Just call and leave a message, or e-mail me and I'll print it out and mail it to you!

Rick

904-461-3146

Internet:

76545.1726@compuserve.com

## FOR SALE HOBBYAIR Respirator System

Same unit as in Aircraft Spruce EAST catalog on page 18. Breath fresh outside air while painting or working with other toxins. In brand new condition with original box, etc. Paid \$370 new, will sell to first \$200 or best offer. I used it only once when painting my Long EZ.

Call Rick Lavoie @ 904-461-3146  
or e-mail Internet:  
76545.1726@compuserve.com

## X-Mass Gift Idea

Know someone that is interested in Velocity's? Why not give a **gift subscription** (we will send a gift certificate in your name to the recipient)

## Buy Sell or Trade

Free and exclusive  
to all *Velocity Views* Subscribers.

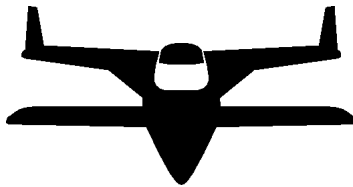

### FOR SALE Velocity RG Elite

Engine: New IO-360 200HP, all new accessories and chrome package

Propeller: Performance  
Propellers 3-blade wood

Avionics:

Terra digital nav/com, Terra digital Transponder, Terra marker beacon

Garmin GPS 155 IFR, Century 2000 auto pilot altitude

Options:

JPI digital slim-line engine instruments, JPI digital 4-cylinder CHT/EGT/OAT scanner, EI digital fuel flow computer, PS 2000 4-place intercom, Custom electric cabin heat

Strobe lights, Sony CD player  
Ameriking ELT (D cell batteries), (4) cabin vents, Map lights  
Interior: (similar to factory Elite), Sand leather seats and side panels, Brown carpet, Beige head liner

Paint: Pure white Sikkens polyurethane (better than Imron) with black trim

Notes:

Plane was professionally built and everything is new. All parts are aircraft quality or better. It has an airworthiness certificate, has been completely test flown, and is ready for passengers.

Price: \$ Make serious offer

Contact:

Todd Sanderson at 219-925-3945  
or 219-925-6939 or

E-mail VELOCELITE@aol.com

## FOR SALE Lycoming LIO 360 C1E6

1900 SMOH. New B&C starter. New Airwolf external oil filter assy. Fresh vacuum pump, fresh fuel pump, recent mags. New powder-coated engine mount, metalized exhaust. Intake pipes modified for Velocity. Velocity engine baffling, installed. New ignition harnesses, fuel injectors, plugs, tubes, hoses, gaskets, thermostat. Ready to bolt on. Virtually a turnkey package. Thoroughly inspected and test run by Don George Engines. Runs fine! \$12,921 Also available: New Woofter prop extension with fitted cover. \$590 New Performance 3-blade prop with bolts. \$1715.

Dave Black / 703-590-2221

internet: asterisk@idsonline.com

## FOR SALE VELOCITY STUFF

Parting out Velocity selling the following: Vision Micro system VM1000 \$2300, Fly Buddy GPS \$1000, Magellan EC-10 moving map GPS \$1000, nav strobe system \$350, Narco AT150 W/tray \$500, grey leather seats \$1000, Mx170 nav/com with tray \$700, Nav Aid auto pilot \$1000, Icom com radio w/tray \$600, Elt \$125, call Moses Ezekiel @ 954-389-9011

## FOR SALE VELOCITY RG

For Sale: 1992 Velocity RG, 200 TTAF, 1050 SMOH, 80 STO, Full IFR Panel, Coupled Autopilot, Vision Micro Monitor, Many Custom Features, \$104,900, 716-655-6209



by Duane & Scott Swing

## Builder Notices

The 173 FG and 173 FG Elite use a larger nose fork and tire assembly. We found that the steel spacers that center the wheel in the fork are too small. This allows side movement which is not allowed. We made the change after the last newsletter was sent out so the new kits all have the correct spacers. Check your set up and let us know if you need the longer ones. The right length is approximately 29/32".

The new style overcenter linkage has fork ends that are like tabs welded on the front and back sides of the tubing. The older style had a "U" shaped fork end welded all around the end. Ever since this new design was developed, for ease of fabrica-

tion, we have suspected that it may be a little weaker at the ends. The designer thought that it would be comparable to the other. Not believing that, we tested the linkage and found the fork ends to buckle at 6000 to 7000 lbs. When testing the old design, it went up to 8000 to 9000 lbs. Even though 3 1/2 tons per side should be adequate, we know of two or three linkages that had their fork ends buckle under a hard landing. Knowing this we added gussets to the new design to strengthen it. This resulted in a buckling at approx. 12,000 lbs. We have added these gussets to all the linkages in stock. If you send your linkage back to us, we will weld those gussets in and send it back. We can also send you the gussets if you know someone who can weld them in. After these gussets are welded in, you will have to round off the top of your gear leg so that the gussets will clear as the gear moves through its motion. Those of you that already have these gussets should make sure the linkage will rotate around the top of the gear without touching.

VELOCIPOXY, like Alphapoxy, needs to be mixed 2 part resin to 1 part hardener. If you accidentally mix it 2 parts hardener to 1 part resin, this mixture will not cure correctly. This has happened to a few

builders so we want to remind you to watch what you are doing.

ELITES - The front seat inertia reels are mounted to reinforced webs that are installed behind the carbon stiffeners. This web has not been supplied in the kit but it consists of a laminate of fiberglass that is approx. 1/8" thick. About 3 layers of triax will give you this.

When you are doing the Triax lay-up in the gear area that goes from the gear bulkhead onto the fuselage and onto the firewall it is easiest to insert one ply at a time because of the sharp angles.

The main reason for the offset elevator torque tube set up was to be able to seal the fuselage easier. The two that we have seen lately have not taken advantage of this. You must add some fuselage (foam and glass) back in the cavity of the trailing edge of the canard. Think of it as sealing off the hole that is left when installing the canard. After the hole has been put in the fuselage for passage of the torque tube, you will make a couple of cuts to then be able to remove the canard with the torque tube. The cut coming down the backside of the canard must extend down to the middle of the passage hole and then go forward into the hole. Then, a cut is made that extends from the middle of the front side of the hole to the bottom corner of the canard. This allows easy removal of the canard while keeping a nice seal around the opening. See the diagram below.

## Let's be constructive

*Continued from page 2*

perfect as possible (not just the factory). If I find an error and do not let Jeff know about it, the next builder behind me will make that same mistake (that guy may be you). Thus if we all chip in and make a commitment to be constructive and get these suggestions to Jeff, we all WIN!

The best thing to do is to call and ask for Jeff. If he agrees that there is a problem, or a better explanation or drawing is needed, he will review it with Scott and issue a KPC and update the manual. The factory now has the software inhouse to keep all 8 versions of the manuals up to date. It is no easy task!

The Swings have made investments of time and money during the past two years for new builder's manuals, new flight manual, new tapes, and this newsletter. Let's work with them and stop complaining!

Thanks for listening.

Rick

## CANARD FUSELAGE CUTOUT DIAGRAM

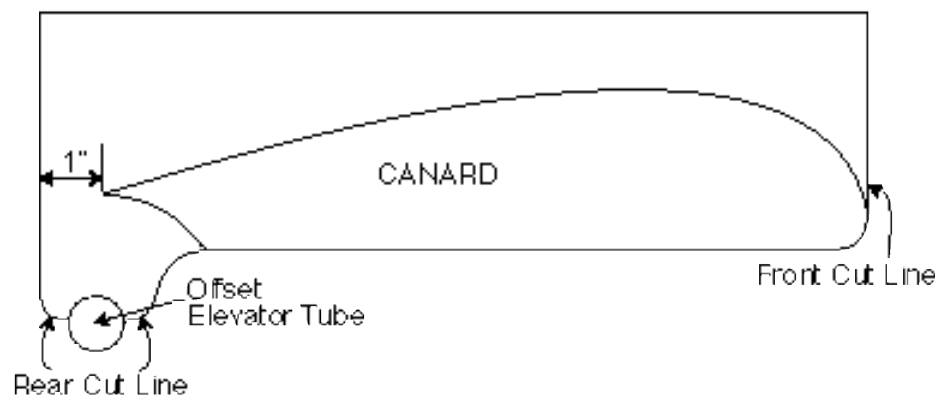

### Delivery Dates

<b>Quarter:</b>	<b>Mailed by:</b>
1st	January 15th
2nd	April 15th
3rd	July 15th
4th	October 15th

### Submission Deadlines

<b>Quarter:</b>	<b>Mail Date:</b>
1st	December 1st
2nd	March 1st
3rd	June 1st
4th	September 1st

Listed below are **4 options** for submitting your text. Please send us **photos** and drawings too!

1) Send it on a **3-1/2" computer disk** (Mac or DOS). This saves us from re-typing all that text. Don't format your text, just give us raw text, with no underlining, bold, or any other type of formats. We also can take Zip100 or Syquest drives.

2) **E-Mail** your file to me on CompuServe to User 76545,1726, or via the internet 76545.1726@compuserve.com

3) If you don't have access to a computer, then we can scan in your **typed** page.

4) If you **print neatly** so we can read it clearly, we'll input it on our computer for you!

Note: If you need your photos & materials returned, please include a self addressed envelop.

*Velocity Views*  
is published **Quarterly** by:  
**Lavoie Graphics**  
26 Marshview Dr  
St. Augustine, FL 32084-5873  
Rick Lavoie, Publisher  
904-461-3146  
(voice or fax)

*Velocity Views* newsletter is published in cooperation with Velocity Inc. (the factory). Prior to printing, the factory reviews each volume published for accuracy.

*Velocity Views* newsletter material has been supplied voluntarily from the Velocity Factory, Builders, & Vendors. This material is printed for informational purposes only. Opinions expressed are those of the author. Lavoie Graphics & Rick Lavoie do not endorse and are not liable for the contents of such material. Use of this material is at your own risk. Any variance from the factory plans is a high risk endeavor. Any contemplated modifications should be reviewed and approved by Velocity Inc.

*Velocity Views* is a Trademark of Lavoie Graphics

**Copyright** © 1994 - 96 Lavoie Graphics All Rights Reserved.

No part may be reproduced or translated, stored in a database or retrieval system, or transmitted in any form by electronic, mechanical, photocopying, recording, or other means, except as expressly permitted by the publisher.

## Subscriptions

- **1996 Calendar Year Subscription** (Volumes 5-8): The annual cost is \$35.00 for mailing addresses within the United States. For all other mailing addresses, the cost is \$43.00 in US funds (covers air mail & special handling).

All subscriptions are sold on a calendar year basis. New subscribers joining mid year will be provided with back issues for that calendar year.

- **1995 Back Issues** (Volumes 1-4) are available for sale at \$35.00 in US funds. Specify that you want 1995 back issues when ordering.

- Look at the top of your mailing label for the final volume number your subscription covers. To help keep our costs down, no invoice will be mailed to you. Simply mail a check to Rick Lavoie each year to keep your newsletter coming.

It is more cost efficient for us if you pay by check, but if you elect to pay with Master Card/Visa, be sure to include the following, printed clearly:

- Name as it appears on your Card.
- Credit Card number
- Expiration Date
- Master Card or Visa?

NOTE: On your statement, the charge will be processed in the name of Lavoie Graphics



Rick Lavoie, Newsletter Editor  
26 Marshview Dr  
St. Augustine FL 32084-5873

FIRST CLASS

FORWARD & ADDRESS CORRECTION

"Paid thru Vol?" on your label indicates the final volume your subscription covers.

# VELOCITY VIEWS

Volume 8

## Vukos' First Flight: Velocity RG Elite



Judy and I met John and Gail Vukos two years ago at Central States Association's "Rough River" Fly-in in Kentucky. We both flew Long EZs, but deep down wished we had Velocities. When Jimmy Dallas landed that night in his Velocity, we both spent time admiring all the advantages Velocity had to offer. Within a few short months, both John and I had put down deposits for Velocity kits. We have kept in close contact since then, and I am looking forward to hopefully seeing John's new pride and joy at the November Florida fly-in.

It took John only a year and a half to complete his Velocity. I e-mailed him and asked John to answer a few basic questions for us Velocityites still slaving away on our projects. The following is John's response.

*Rick*

My first flight was June 8th, 1996. I started my project on Jan. 1st 1995. It took me 1550 hours to complete. I had built a Long EZ before, so that experience helped. I built my Velocity to fly, not as a show plane. I can be proud of it, but it isn't detailed like some that have every phillips head screw oriented the same.

The first flight was fairly uneventful. I was most concerned about not having enough pitch down trim. I needed to reposition the pitch trim spring. Otherwise, it was just getting used to the heavier feel going from a Long EZ to a Velocity. So far, top speed is 184 kt true at 3000 ft 2760 rpm. I cruise at 10,000 ft at 2600 rpm and 170 kt true, burning about 8 gph.

I put in a B&C 60A alternator, Skytec lightweight starter, Strikefinder, RMI uEncoder and

*Continued on page 2*

## In this issue

<b>First Flight</b> .....	<b>1</b>
<i>John Vukos' new Velocity RG Elite</i>	
<b>Let's Be Constructive</b> .....	<b>2</b>
<i>The right way to call when you find an error in the manual</i>	
<b>Factory News</b> .....	<b>3</b>
<i>Builder notices, Franklin engine update, and other news from the Swings</i>	
<b>Safety Corner</b> .....	<b>5</b>
<i>Accident &amp; Incident Reports and Maintenance Service Difficulties.</i>	
<b>Short Circuit</b> .....	<b>7</b>
<i>Electrical, instrument, and avionics related tips from Martin Hadley</i>	
<b>Factory KPCs</b> .....	<b>9</b>
<i>Kit plans changes to keep your manual up-to-date</i>	
<b>2nd Florida Fly-in</b> .....	<b>10</b>
<i>Plan on attending the factory sponsored fly-in to be held Nov 2-3 in historic St Augustine, Florida</i>	
<b>Builder Forum</b> .....	<b>12</b>
<i>Tips, information &amp; letters</i>	
<b>Views from the West</b> .....	<b>21</b>
<i>News from Velocity's west coast service center</i>	
<b>Buy Sell or Trade</b> .....	<b>22</b>
<b>Renewal Invoice</b> .....	<b>23</b>